

### Circulares

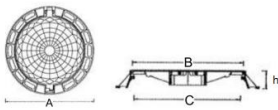

MODELO	A	B	C	h	REF.	RESISTENCIA	PRECIO
250	275	250	220	20	01010001	B-125	9,41 €
300 A	340	300	280	20	01010002	B-125	14,14 €
300 A	340	300	280	20	01010017	D-400	19,90 €
400 A	440	390	380	25	01010003	B-125	23,73 €
400 A	440	390	380	25	01010004	D-400	41,00 €
500 A	540	485	465	25	01010005	B-125	45,33 €
500 A	540	485	465	25	01010006	D-400	56,13 €
600 A	670	600	550	35	01010007	B-125	56,54 €
600 A	670	600	550	35	02010010	C-250	63,00 €
600 A	690	600	570	40	01010008	D-400	88,36 €
600 (ART)	740	580	550	70	02010003	400KN	91,36 €
600 A (ART)	800	600	560	90	02010001	D-400	121,62 €
600 A	800	600	560	80	01010011	E-600	212,05 €
650 (ART)	820	630	590	100	02010004	D-400	132,30 €
700 A	800	700	665	35	01010012	B-125	106,02 €
700 A	800	700	665	40	01010013	D-400	132,53 €
800 A	900	800	750	40	01010014	D-400	189,07 €

#### CARACTERISTICAS:

- Norma UNE-EN-124
- Fundición Dúctil.
- Superficie Antideslizante
- Pintura Negra Antioxidante

"A" FABRICACION PROPIA CON POSIBILIDAD DE ESCUDO E INSCRIPCION SOBRE RELIEVE

### Cuadradas

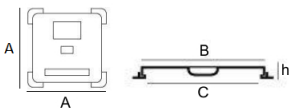

MODELO	AxA	BxB	CxC	h	REF.	RESISTENCIA	PRECIO
200x200	200x200	190x190	150x150	20	02020001	B-125	9,90 €
250x250	275x275	250x250	225x225	20	01020001	B-125	11,78 €
300x300	300x300	290x290	250x250	25	02020002	B-125	14,70 €
300x300 A	300x300	270x270	250x250	20	01020002	B-125	14,14 €
300x300 A	330x330	300x300	270x270	20	01020003	D-400	23,73 €
400x400	400x400	390x390	350x350	30	02020003	B-125	21,00 €
400x400 A	400x400	365x365	350x350	25	01020004	B-125	25,92 €
400x400 A	430x430	385x385	340x340	30	02020022	B-125	24,30 €
400x400 A	430x430	385x385	340x340	30	02020026	C-250	35,20 €
400x400 A	450x450	400x400	385x385	30	01020005	D-400	43,19 €
400x400 A	450x450	400x400	385x385	30	02020027	D-400	44,80 €
500x500	500x500	490x490	450x450	30	02020004	B-125	39,90 €
500x500 A	540x540	490x490	460x460	30	02020034	B-125	40,50 €
500x500 A	540x540	490x490	460x460	30	02020035	C-250	48,10 €
500x500 A	540x540	490x490	460x460	30	01020007	D-400	62,63 €
600x600	600x600	590x590	550x550	30	02020005	B-125	55,66 €
600x600 A	650x650	595x595	560x560	35	02020029	B-125	56,90 €
600x600 A	650x650	595x595	560x560	35	02020036	C-250	80,50 €
600x600 A	650x650	595x595	560x560	35	01020009	D-400	123,70 €
700x700	700x700	690x690	650x650	40	02020006	B-125	107,10 €
700x700 A	780x780	700x700	675x675	45	01020010	D-400	159,04 €
800x800	800x800	780x780	740x740	45	02020007	B-125	136,50 €
800x800 A	885x885	800x800	765x765	45	01020011	D-400	215,57 €
900x900	900x900	880x880	840x840	45	02020008	B-125	189,00 €
1000x1000	1000x1000	950x950	910x910	50	02020028	B-125	298,30 €
1000x1000 A	1100x1100	1000x1000	950x950	45	01020012	B-125	309,25 €
1000x1000 A	1100x1100	1000x1000	950x950	45	01020013	D-400	371,10 €

#### CARACTERISTICAS:

- Norma UNE-EN-124
- Fundición Dúctil.
- Superficie Antideslizante
- Pintura Negra Antioxidante
- Marco Hidráulico

"A" FABRICACION PROPIA CON POSIBILIDAD DE ESCUDO E INSCRIPCION SOBRE RELIEVE

## Rectangulares



	A x B	C x D	E x F	H			
MODELO	MARCO	TAPA	LUZ	ALTURA	REF.	RESISTENCIA	PRECIO
500x400	530x435	500x400	485x385	30	01030001	B-125	51,79 €
600x400	650x450	600x400	580x380	30	01030002	B-125	64,80 €
800x600	850x650	800x600	770x570	40	01030003	B-125	114,92 €
800x600	850x650	800x600	770x570	45	01030007	D-400	199,00 €
800x700	830x730	800x700	770x670	40	01030004	B-125	166,11 €

### CARACTERÍSTICAS:

Realizadas en fundición dúctil con superficie antideslizante.

## Tipo Campsa

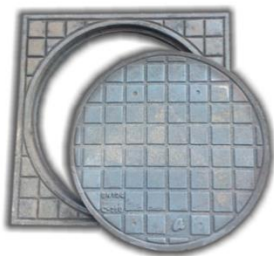

	A x A	B	C	h			
MODELO	MARCO	TAPA Ø	LUZ Ø	ALTURA	REF.	RESISTENCIA	PRECIO
300 A	400x400	300	285	20	01040001	B-125	25,10 €
400 A	450x450	400	385	25	01040002	B-125	36,72 €
560 A	600x600	560	530	35	01040003	B-125	70,68 €
600 A	660x660	600	555	40	01040005	D-400	159,04 €

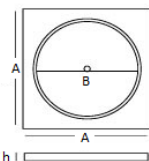

## Cuadradas Abisagradas



	A x A	B X B	C X C	h			
MODELO (tapa)	MARCO	LUZ	LUZ	ALTURA	REF.	RESISTENCIA	PRECIO
300x300	320x320	270x270	270x270	25	02040001	B-125	22,50 €
390x390	430x430	370x370	370x370	25	02040002	B-125	43,10 €
490x490	530x530	470x470	470x470	30	02040003	B-125	49,30 €
300x300	320x320	270x270	270x270	25	02040004	C-250	24,90 €
390x390	430x430	370x370	370x370	25	02040005	C-250	48,40 €
490x490	530x530	470x470	470x470	30	02040006	C-250	56,20 €

### CARACTERÍSTICAS

- Norma UNE-EN-124
- Fundición Dúctil.
- Superficie Antideslizante
- Pintura Negra Antioxidante
- Sistema antirrobo con posibilidad de cerradura

## Hormigonables

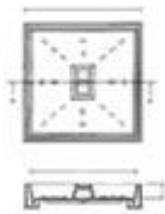
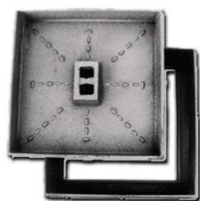

	A x A	B X B	C X C	h			
MODELO (marco)	TAPA	LUZ	LUZ	ALTURA	REF.	RESISTENCIA	PRECIO
400x400	380x380	340x340	340x340	50	02130001	B-125	42,50 €
500x500	480x480	440x440	440x440	50	02130002	B-125	64,30 €
600x600	580x580	540x540	540x540	50	02130003	B-125	82,50 €
700x700	670x670	600x600	600x600	50	02130004	B-125	137,60 €
400x400	380x380	340x340	340x340	100	02130005	C-250	57,40 €
500x500	480x480	440x440	440x440	100	02130006	C-250	82,50 €
600x600	580x580	540x540	540x540	100	02130007	C-250	105,00 €
700x700	670x670	600x600	600x600	100	02130008	C-250	167,80 €
400x400	380x380	340x340	340x340	100	02130009	D-400	75,00 €
500x500	480x480	440x440	440x440	100	02130010	D-400	112,60 €
600x600	580x580	540x540	540x540	100	02130011	D-400	137,70 €
700x700	670x670	600x600	600x600	100	02130012	D-400	212,10 €

### CARACTERÍSTICAS

- Norma UNE-EN-124 / • Fundición Dúctil.
- Cavidad rellenable / • Pintura Negra Antioxidante

# Estancas

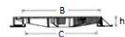
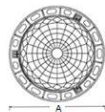

	A	B	C	h			
MODELO	ARO ∅	TAPA ∅	LUZ ∅	ALTURA	REF.	RESISTENCIA	PRECIO
600	850	630	600	100	02010008	D-400	162,50 €

## CARACTERISTICAS:

- Norma UNE-EN-124
- Fundición Dúctil.
- Superficie Antideslizante
- Pintura Negra Antioxidante
- Junta polietileno
- Cierre con tornillos



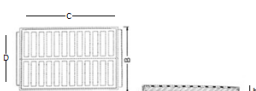

Sin Bisagra	A x B	C x D	h						
	MODELO (reja)	MARCO	LUZ	ALTURA	RESISTENCIA	REF. REJA	PRECIO REJA	REF. JUEGO	PRECIO JUEGO
 	230x170	250x200	190x135	30	C-250	01050014	7,16 €	01050001	12,36 €
	330x180	350x200	300x145	30	C-250	01050015	9,70 €	01050002	16,22 €
	380x180	400x200	340x145	30	C-250	01050016	10,80 €	01050003	17,27 €
	400x300	440x340	370x270	40	C-250	01050019	25,92 €	01050006	38,86 €
	450x250 *	490x290	420x220	40	C-250	01050018	25,92 €	01050005	38,86 €
	500x120	530x150	470x95	30	C-250	01050017	10,80 €	01050004	19,45 €
	500x300 *	540x340	470x270	40	D-400	01050022	32,39 €	01050009	43,19 €
	500x350	540x390	470x320	40	D-400	01050023	36,72 €	01050010	54,97 €
	500x500	550x550	470x470	40	D-400	01050024	62,83 €	01050011	75,99 €
	540x140	580x190	520x120	40	D-400	01050020	19,45 €	01050007	32,39 €
	600x220	650x280	560x180	35	D-400	01050021	28,07 €	01050008	41,23 €
	600x400 *	680x480	560x360	60	D-400	01050025	62,83 €	01050012	81,31 €
	700x400 *	800x500	675x365	60	D-400	01050026	64,80 €	01050013	84,83 €

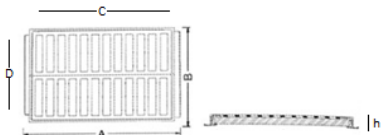
\* DIAGONAL

Abatibles Rectangulares	A x B	C x D	h			
	MODELO (marco)	REJA	ALTURA	REF.	RESISTENCIA	PRECIO
 	440x230	400x200	35	02050001	C-250	25,00 €
	490x270	470x250	35	02050002	C-250	30,60 €
	415x320	400x300	35	02050003	C-250	31,90 €
	570x370	550x350	35	02050004	C-250	39,15 €
	650x410	600x400	40	02050005	C-250	68,50 €
	700x350	670x320	40	02050015	C-250	67,40 €
	530x270	460x230	35	02050011	D-400	69,40 €
	620x470	600x400	40	02050016	D-400	98,80 €

### CARACTERISTICAS

- Norma UNE-EN-124
- Fundición Dúctil.
- Superficie Antideslizante
- Pintura Negra Antioxidante
- Rejilla Abisagrada

Abatibles Cuadradas	A x A	h			
	MODELO (marco)	ALTURA	REF.	RESISTENCIA	PRECIO
 	300x300	30	02050013	C-250	31,90 €
	400x400	30	02050006	C-250	49,20 €
	500x500	30	02050007	C-250	67,80 €
	600x600	30	02050008	C-250	115,60 €
	700x700	30	02050012	C-250	166,60 €
	800x800	30	02050017	C-250	213,80 €
	400x400	35	02050014	D-400	56,40 €
	500x500	35		D-400	94,10 €
	600x600	35		D-400	125,40 €

### CARACTERISTICAS

- Norma UNE-EN-124 / • Fundición Dúctil. / • Superficie Antideslizante • Pintura Negra Antioxidante
- Rejilla Abisagrada

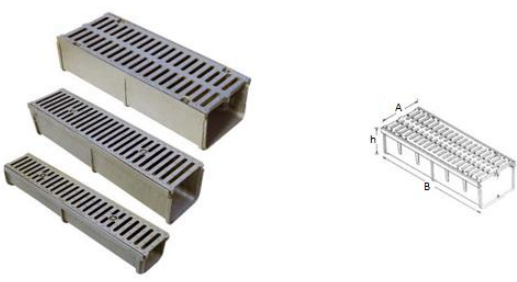
Con Canal (fundición)	A x B	h				
	MODELO	REJA	ALTURA	REF.	RESISTENCIA	PRECIO
	1000x130	1000x110	110	02060004	D-400	59,50 €
	750x200	750x170	140	02060002	D-400	70,40 €
	750x300	750x270	160	02060003	D-400	109,20 €
	750x500	750x470	400		D-400	
	<b>CARACTERISTICAS</b> <ul style="list-style-type: none"> <li>• Norma UNE-EN-124</li> <li>• Fundición Dúctil (canal incluido)</li> <li>• Superficie Antideslizante</li> <li>• Pintura Negra Antioxidante</li> <li>• Sujeción Mediante Tornillos</li> </ul>					

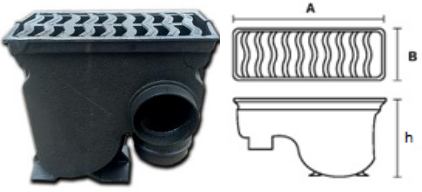
IMBORNAL SIFONICO	A x B	h					
	MODELO	LONG. EXT.	ALTURA	SALIDA Ø	REF.	RESISTENCIA	PRECIO
	1	565x250	570	200	02070002	C-250	220,00 €
	2	565x250	570	200	02070001	D-400	275,00 €
	<b>CARACTERISTICAS</b> <ul style="list-style-type: none"> <li>• Norma UNE-EN-124</li> <li>• Fundición Dúctil</li> <li>• Superficie Antideslizante</li> <li>• Pintura Negra Antioxidante</li> <li>• Rejilla Abisagrada</li> <li>• Superficie de Absorción: 6,3 dm<sup>2</sup></li> </ul>						

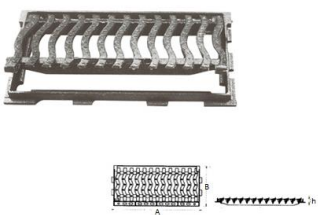
Ondas	A x B	h				
	MODELO	MARCO	ALTURA	REF.	RESISTENCIA	PRECIO
	ONDAS	810x350	40	02050009	C-250	61,80 €
	<b>CARACTERISTICAS</b> <ul style="list-style-type: none"> <li>• Norma UNE-EN-124</li> <li>• Fundición Dúctil.</li> <li>• Superficie Antideslizante</li> <li>• Pintura Negra Antioxidante</li> <li>• Rejilla Abisagrada</li> </ul>					

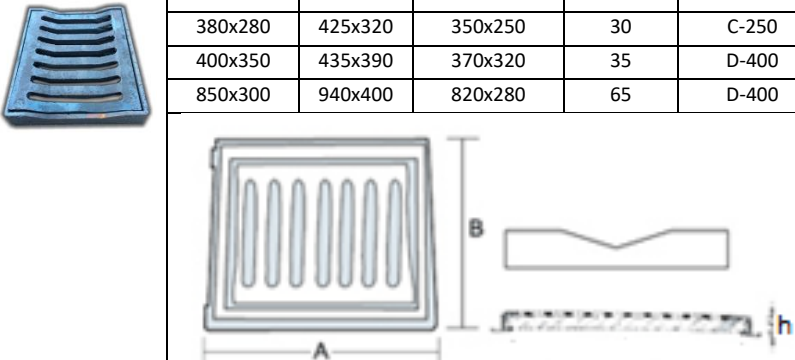
Cóncavas	A x B	C x D	h						
	MODELO (reja)	MARCO	LUZ	ALTURA	RESISTENCIA	REF. REJA	PRECIO REJA	REF. JUEGO	PRECIO JUEGO
	400x260	445x305	365x230	45	C-250	01060005	25,46 €	01060001	41,70 €
	380x280	425x320	350x250	30	C-250	01060006	20,50 €	01060002	34,54 €
	400x350	435x390	370x320	35	D-400	01060007	36,72 €	01060003	58,90 €
	850x300	940x400	820x280	65	D-400	01060008	78,54 €	01060004	137,44 €
	<b>CARACTERISTICAS</b> <ul style="list-style-type: none"> <li>• Norma UNE-EN-124</li> <li>• Fundición Dúctil.</li> <li>• Superficie Antideslizante</li> <li>• Pintura Negra Antioxidante</li> <li>• Rejilla Abisagrada</li> </ul>								

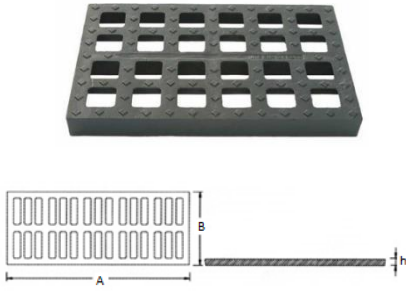
<h2 style="text-align: center;">Cuadradillo</h2> 	A x B	h			
	MODELO (reja)	ALTURA	REF.	RESISTENCIA	PRECIO
	750x500	70	02080006	D-400	119,80 €
	1000x500	70	02080001	D-400	152,00 €
<b>CARACTERISTICAS</b> <ul style="list-style-type: none"> <li>• Norma UNE-EN-124</li> <li>• Fundición Dúctil.</li> <li>• Superficie Antideslizante</li> <li>• Pintura Negra Antioxidante</li> </ul>					

<h2 style="text-align: center;">Para Canal (Sin Marco)</h2> 	A x B	h			
	MODELO (reja)	ALTURA	REF.	RESISTENCIA	PRECIO
	500x130	18	16010001	B-125	13,80 €
	500x130	18	16010003	C-250	13,80 €
	500x130	18	16010005	D-400	18,70 €
	500x200	20	16010007	C-250	21,00 €
	500x200	20	16010009	D-400	22,40 €
	500x260	20	16010011	C-250	27,10 €
	500x260	20	16010012	D-400	30,30 €
<b>CARACTERISTICAS</b> <ul style="list-style-type: none"> <li>• Norma UNE-EN-124</li> <li>• Fundición Dúctil.</li> <li>• Superficie Antideslizante</li> <li>• Pintura Negra Antioxidante</li> <li>• Orificio para Tornillo</li> </ul>					

<h2 style="text-align: center;">Bordillos</h2> 	A x B	h			
	MODELO	ALTURA	REF.	RESISTENCIA	PRECIO
	560x150	200	04110001	C-250	34,36 €
	800x150	190	04110002	C-250	101,60 €
<b>CARACTERISTICAS</b> <ul style="list-style-type: none"> <li>• Fundición Dúctil</li> <li>• Superficie Antideslizante</li> <li>• Pintura Negra Antioxidante</li> </ul>					

<h2 style="text-align: center;">Circulares</h2> 	B	A	C	h			
	MODELO (reja Ø)	ARO Ø	LUZ Ø	ALTURA	REF.	RESISTENCIA	PRECIO
	600	690	570	40	01080001	C-250	82,46 €
	650 *	850	600	100	01080004	D-400	159,60 €
<b>CARACTERISTICAS:</b> <ul style="list-style-type: none"> <li>• Norma UNE-EN-124</li> <li>• Fundición Dúctil.</li> <li>• Superficie Antideslizante</li> <li>• Pintura Negra Antioxidante</li> <li>• El Modelo 650 va Provisto de Bisagra</li> </ul>							



## Reja Con Tapa



	A x B	C x D	h			
MODELO (reja y tapa)	MARCO	LUZ	ALTURA	REF.	RESISTENCIA	PRECIO
400x300	850x350	360x270	40	01070001	C-250	74,61 €

## De Terraza

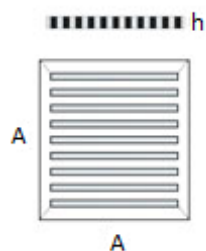

MEDIDA (A x A)	ALTURA (h)	REF.	PRECIO
150x150	12	04120001	3,79 €
200x200	12	04120002	5,22 €
250x250	12	04120003	6,93 €
300x300	12	04120004	9,18 €

<b>Trampillón Calzada</b>	MODELO	TAPA Ø	TUBO Ø	ALTURA	REF.	PRECIO
	310 Ø	125	110	200	04100001	40,31 €



<b>Trampillón Acera</b>	MODELO	TAPA Ø	TUBO Ø	ALTURA	REF.	PRECIO
	125x125	90	90	140	04100002	19,06 €



<b>Tapa Acometida</b>		A x A	B	C	h			
	MODELO	MARCO	TAPA Ø	LUZ Ø	ALTURA	REF.	RESISTENCIA	PRECIO
	400	590x590	400	360	70	01040006	C-250	108,50 €

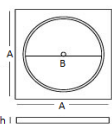



**Tapas de Servicio - GALASA**

<b>TRAMPILLONES</b>	MODELO	TAPA Ø	TUBO Ø	ALTURA	REF.	PRECIO
	125x125	90	90	140	04100002	19,06 €
	315x315	125	96	190	04100005	41,00 €

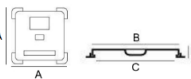

<b>TAPAS</b>		A x A	B x B	C x C	h			
	MODELO (marco)	TAPA	LUZ	ALTURA	REF.	RESISTENCIA	PRECIO	
	400x400	390x390	350x350	30	02020022	B-125	24,30 €	
	400x400	390x390	350x350	30	02020026	C-250	35,20 €	



# Tapas de Servicio – IBERDROLA

<b>MOD. M1-T1</b>		A x B	C x D	E x F	h			
MODELO	LONG. EXT.	TAPA	LUZ	ALTURA	REF.	RESISTENCIA	PRECIO	
M1-T1	580x440	550x410	510x360	60	76010004	B-125	114,50 €	
<ul style="list-style-type: none"> <li>• Norma UNE-EN-124</li> <li>• Fundición Dúctil</li> <li>• Superficie Antideslizante</li> <li>• Pintura Negra Antioxidante</li> <li>• Trasera Hormigonable</li> </ul>								

<b>MOD. M2-T2</b>		A x B	C x D	E x F	h			
MODELO	LONG. EXT.	TAPA	LUZ	ALTURA	REF.	RESISTENCIA	PRECIO	
M2-T2	700x700	670x670	600x600	60	76010002	B-125	140,80	
<ul style="list-style-type: none"> <li>• Norma UNE-EN-124</li> <li>• Fundición Dúctil</li> <li>• Superficie Antideslizante</li> <li>• Pintura Negra Antioxidante</li> <li>• Trasera Hormigonable</li> </ul>								

<b>MOD. TMC-MMC</b>		A x B	C x D	E x F	h			
MODELO	LONG. EXT.	TAPA	LUZ	ALTURA	REF.	RESISTENCIA	PRECIO	
TMC-MMC	1340x925	4 TAPAS TRI	1180x760	100	76010003	D-400	1.269,40 €	
<ul style="list-style-type: none"> <li>• Norma UNE-EN-124</li> <li>• Fundición Dúctil</li> <li>• Superficie Antideslizante</li> <li>• Pintura Negra Antioxidante</li> </ul>								

<b>MOD. M3-T3</b>		A	B	C	h			
MODELO	LONG. EXT. Ø	TAPA Ø	LUZ Ø	ALTURA	REF.	RESISTENCIA	PRECIO	
M3-T3	850	650	600	100	76010001	D-400	180,30 €	
<ul style="list-style-type: none"> <li>• Norma UNE EN-124.</li> <li>• Fundición Dúctil</li> <li>• Superficie antideslizante.</li> <li>• Pintura negra antioxidante</li> <li>• Provisto de junta de vinilo de acetato para asegurar la insonorización y un correcto asiento.</li> <li>• Cierre de seguridad.</li> </ul>								

# Tapas de Servicio – TELEFÓNICA

Fundición		A x B	C x D	E x F	h			
MODELO	LONG. EXT.	TAPA	LUZ	ALTURA	REF.	RESISTENCIA	PRECIO	
TIPO M	400x400	380x380	360x360	30	02030001	B-125	26,00 €	
TIPO H	1000x800	995x380 (x2)	900x700	60	02030002	B-125	250,40 €	
TIPO H	1000x800	995x380 (x2)	900x700	60	02030003	D-400	352,00 €	
TIPO D	1200x1000	995x380 (x3)	1100x900	60	02030004	B-125	365,20 €	
TIPO D	1200x1000	995x380 (x3)	1100x900	60	02030005	D-400	525,00 €	

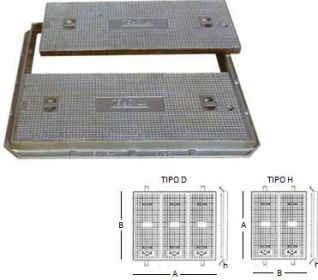

- Norma UNE-EN-124
- Fundición Dúctil.
- Superficie Antideslizante
- Pintura Negra Antioxidante
- Marco Angular en tipo H y D

HORMIGON		A x B	C x D	E x F	h			
MODELO	LONG. EXT.	TAPA	LUZ	ALTURA	REF.	RESISTENCIA	PRECIO	
TIPO M	410x410	390x390	340x340	70	78010001	B-125	126,50 €	
TIPO H	940x840	830x460 (x2)	890x780	70		B-125	480,90 €	
TIPO D	1250x1060	1030x300 (x4)	1190x1000	70		B-125	977,60 €	
TIPO DM	1060x620	1040x300 (x2)	980x560	70		B-125	619,50 €	



- Hormigón HA-30 N/mm2
- Armadura B 500 S.
- Homologadas por TELEFÓNICA
- Uso exclusivo peatonal

# Tapas de Servicio – ENDESA

MOD. A1		A x B	C x D	E x F	h			
MODELO	MARCO	TAPA	LUZ	ALTURA	REF.	RESISTENCIA	PRECIO	
A1 A	750x650	720x620	700x600	65	02100001	B-125	106,10 €	
A1 A	750x650	720x620	700x600	65	02100002	D-400	140,00 €	
A1*	750x650	720x620	700x600	75	02090005	D-400	207,80 €	
A2 A	1260x735	720x620 (x2)	1140x600	60	02100008	B-125	205,00 €	
A2 A	1260x735	720x620 (x2)	1140x600	60	02100006	D-400	281,40 €	

\* MODELO HOMOLOGADO POR LA COMPAÑIA  
"A" FABRICACION PROPIA CON POSIBILIDAD DE ESCUDO E INSCRIPCION SOBRE RELIEVE

**MOD. A2**



**CARACTERISTICAS:**

- Norma UNE-EN-124
- Fundición Dúctil.
- Superficie Antideslizante
- Pintura Negra Antioxidante
- Marco Angular en A2

# Tapas de Servicio – UNELCO

MOD. A2 / A3		A x B	C x D	E x F	h			
MODELO	MARCO	TAPA	LUZ	ALTURA	REF.	RESISTENCIA	PRECIO	
A2	750x500	680x430	630x390	40		B-125		
A3	1000x750	930x680	880x630	40		B-125		



- Norma UNE-EN-124
- Fundición Dúctil
- Superficie Antideslizante
- Disponibles con B.T. y A.T. u otros marcajes

MOD. B2		A	B	C	h			
MODELO	ARO Ø	TAPA Ø	LUZ Ø	ALTURA	REF.	RESISTENCIA	PRECIO	
B2	1000	710	660	150		D-400		

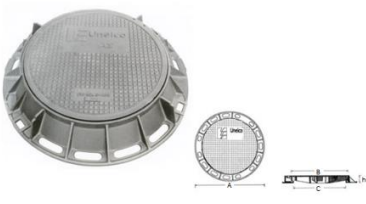

- Norma UNE-EN-124
- Fundición Dúctil
- Superficie Antideslizante
- Disponibles con B.T. y A.T. u otros marcajes

# Tapas de Servicio – AMVISA

AMVISA		MODELO (marco)	TAPA	LUZ	ALTURA	REF.	RESISTENCIA	PRECIO
		500x500	380x380	360x360	80	02110001	C-250	79,50 €

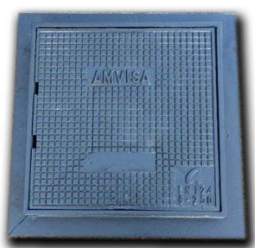

**CARACTERISTICAS:**

- Norma UNE-EN-124
- Fundición Dúctil
- Superficie Antideslizante
- Pintura Negra Antioxidante

TELECOMUNICACIONES		A x B	C x D	E x F	h			
MODELO	LONG. EXT.	TAPA	LUZ	ALTURA	REF.	RESISTENCIA	PRECIO	
TELECO 1	880x880	2 TAPAS (triángulo)	750x750	100	02120002	D-400	347,50 €	
TELECO 2	1340x925	4 TAPAS (triángulo)	1180x760	100	02120001	D-400	672,00 €	

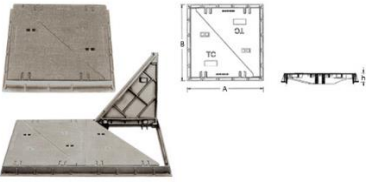

- Norma UNE-EN-124
- Fundición Dúctil
- Superficie Antideslizante
- Pintura Negra Antioxidante

## Artículos para Provincias - MURCIA

MURCIA		MODELO	MARCO (AxA)	ALTURA (h)	RESISTENCIA	REF.	PRECIO
 		400x400*	440x440	40	C-250	02020020	75,00 €
		400x400	460x460	25	B-125	02020019	27,50 €

**CARACTERISTICAS:**

- Norma UNE-EN-124
- Fundición Dúctil.
- Superficie Antideslizante
- Pintura Negra Antioxidante
- Marco Hidráulico
- Modelos Homologados por el Ayuntamiento
- \*Abisagrado y con cerradura inox

## Artículos para Provincias - SANTANDER

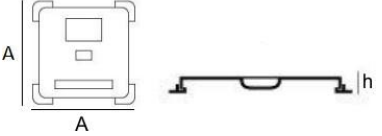
SANTANDER		MODELO	MARCO (AxA)	ALTURA (h)	RESISTENCIA	REF.	PRECIO
 		300x300	330x330	45	B-125	02040007	39,00 €
		<p><b>CARACTERISTICAS:</b></p> <ul style="list-style-type: none"> <li>• Norma UNE-EN-124</li> <li>• Fundición Dúctil.</li> <li>• Abisagrado</li> <li>• Superficie Antideslizante</li> <li>• Pintura Negra Antioxidante</li> </ul>					

# Artículos para Provincias - ALMERIA

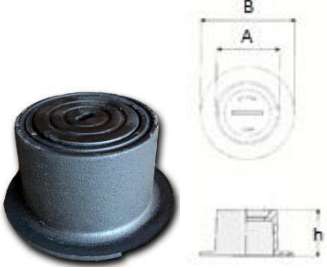
<b>TRAMPILLON</b> 	MEDIDA $\varnothing$ (A)	TAPA $\varnothing$	BASE $\varnothing$ (B)	ALTURA (h)	REF.	PRECIO
		170	120	230	120	04090001

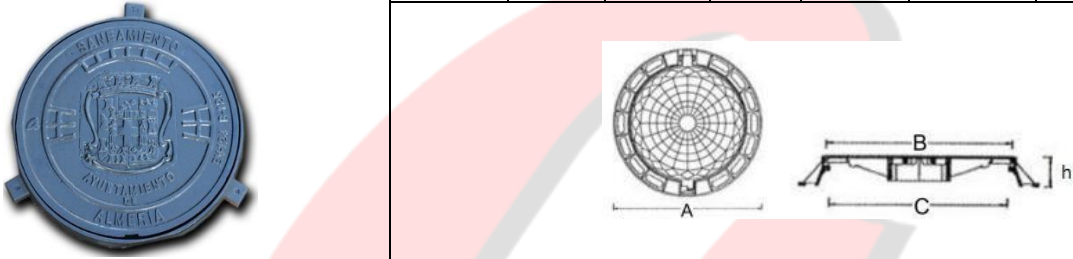
<b>TAPA 400 <math>\varnothing</math></b> 		A	B	C	h			
	MODELO	ARO $\varnothing$	TAPA $\varnothing$	LUZ $\varnothing$	ALTURA	REF.	RESISTENCIA	PRECIO
	400	430	395	360	20	14010001	B-125	24,60 €

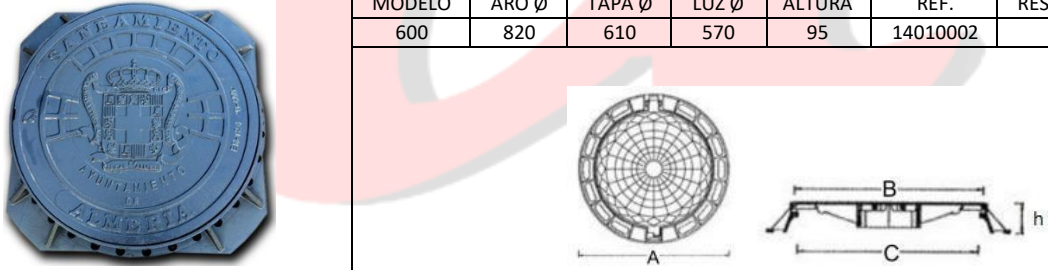
<b>TAPA 600 <math>\varnothing</math></b> 		A	B	C	h			
	MODELO	ARO $\varnothing$	TAPA $\varnothing$	LUZ $\varnothing$	ALTURA	REF.	RESISTENCIA	PRECIO
	600	820	610	570	95	14010002	D-400	115,00 €

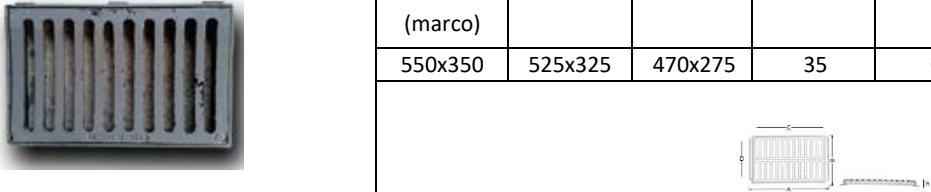
<b>REJA</b> 		A x B	C x D	h			
	MODELO (marco)	REJA	LUZ	ALTURA	RESISTENCIA	REF.	PRECIO
	550x350	525x325	470x275	35	C-250	14020001	52,30 €

# Artículos para Provincias – ZARAGOZA

MOD. 400x400 / 600x600	MODELO (marco)	RESISTENCIA	REF.	PRECIO
	400x400	C-250	30010004	59,50 €
	600x600	C-250	30010003	110,00 €



**CARACTERISTICAS:**

- Fundición Dúctil.
- Superficie Antideslizante
- Pintura Negra Antioxidante
- Homologada por el Ayuntamiento

MOD. INCENDIOS	MODELO (tapa)	RESISTENCIA	REF.	PRECIO
	550x440	C-250	30010002	138,60 €



**CARACTERISTICAS:**

- Fundición Dúctil.
- Superficie Antideslizante
- Pintura Negra Antioxidante
- Homologada por el Ayuntamiento

MOD. 650 O	MODELO (tapa)	RESISTENCIA	REF.	PRECIO
	650 Ø	D-400	30010005	348,00 €





**CARACTERISTICAS:**

- Fundición Dúctil.
- Superficie Antideslizante
- Pintura Negra Antioxidante
- Homologada por el Ayuntamiento
- Apoyo Aro/Tapa Torneado

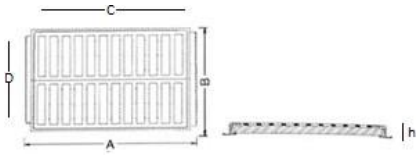

<b>REJA ABATIBLE</b> 	MODELO	MARCO (AxB)	REJA (CxD)	LUZ	h	RESISTENCIA	REF.	PRECIO
		450x300	505x320	425x265	385x230	60	C-250	30010007
								

<b>TRAMPILLON</b> 	MEDIDA Ø (A)	TAPA Ø	BASE Ø (B)	ALTURA (h)	REF.	PRECIO
		170	120	230	120	04090001
						

<b>BOCA DE RIEGO</b> 	TOMA	REF.	PRECIO
	ER45		
	ROSCA ZARAGOZA		
	ROSCA PALENCIA		

<b>TAPA PARA BOCA DE RIEGO</b> 	CUERPO	TAPA	ALTURA	REF.	PRECIO
		300x205	245x165	65	04250001



**Aluminio**

**PUERTAS CONTADOR**



MARCO (A x B)	TAPA	REF.	PRECIO
225x175	200x150	03010001	9,50 €
350x230	300x200	03010003	11,20 €
380x280	350x250	03010005	13,20 €
400x300	360x270	03010007	14,55 €
530x280	500x250	03010009	22,00 €
460x430	430x400	03010010	34,90 €
385x285*	355x250	03010011	23,25 €
LLAVE		03010012	1,00 €
CERRADURA		03010013	2,00 €



+ PROVISTAS DE CERRADURA Y LLAVE CON POSIBILIDAD DE SOPORTE PARA CANDADO.  
\*MOD. CORDOBA CON PINTURA TERMOLACADA

**SUMIDEROS**



A x A	S	h	REF.	PRECIO
MEDIDA	SALIDA Ø	ALTURA	REF.	PRECIO
100x100	30	45	03040001	5,20 €
150x150	50	55	03040002	5,60 €
200x200	75	60	03040003	8,40 €
250x250	90	60	03040004	11,70 €
300x300	110	60	03040005	16,26 €
400x400	125	60	03040006	29,85 €

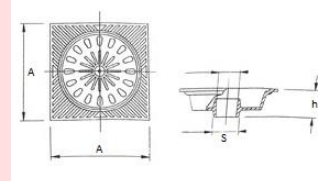

**REGISTROS DE AGUA**



MARCO	TAPA Ø	REF.	PRECIO
200x200	165	03020001	6,10 €

**REGISTROS CUADRADOS**

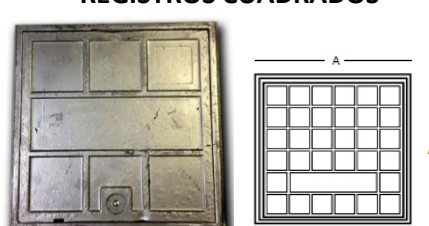

MARCO (A x A)	REF.	PRECIO
200x200	03030001	7,60 €
300x300	03030002	18,95 €
400x400	03030003	31,05 €

## Sumideros de Patio (fundición)

<b>TIPO CAMPANA</b>  	MEDIDA (A x A)	SALIDA Ø (S)	ALTURA (h)	TAPA Ø	REF.	PRECIO
	150x150	50	60	117	04010001	5,39 €
	200x200	60	60	145	04010002	8,49 €
	250x250	85	75	187	04010003	13,05 €
	300x300	100	80	215	04010004	17,61 €
	400x400	115	120	285	04010005	34,36 €

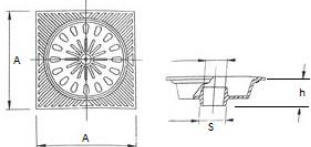

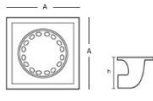

<b>TIPO MADRID</b>  	MEDIDA (A x A)	ALTURA (h)	REF.	PRECIO
	150x150	100	04020001	4,88 €
	200x200	100	04020002	6,93 €
	250x250	120	04020003	11,08 €
	300x300	125	04020004	17,80 €
	400x400	160	04020005	57,80 €

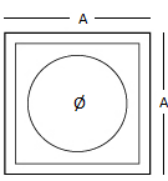

## Registros de Agua

<b>CON TORNILLO</b>  	MODELO (marco)	TAPA Ø	REF.	PRECIO
	150x150	128	04030001	5,89 €
	200x200	165	04030002	8,66 €
	250x250	215	04030003	12,36 €
	300x300	245	04030004	19,17 €



<b>ABISAGRADOS</b>  	MODELO (marco)	ALTURA	REF.	PRECIO
	120x120	35	04040001	9,29 €
	230x150	35	04040004	11,90 €
	250x250	38	04040002	29,28 €
	300x250	42	04040003	33,90 €

# Trampillones De Acometida

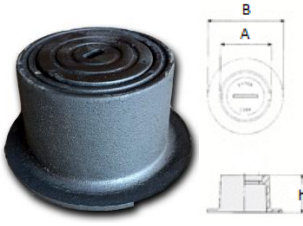
TIPO BUZON	MEDIDA $\varnothing$ (A)	TAPA $\varnothing$	BASE $\varnothing$ (B)	ALTURA (h)	REF.	PRECIO
	170	120	230	120	04090001	18,13 €
	<b>CARACTERISTICAS:</b> <ul style="list-style-type: none"> <li>• Fundición Dúctil</li> <li>• Superficie Antideslizante</li> <li>• Pintura Negra Antioxidante</li> </ul>					

TIPO REDONDO	MODELO	TAPA $\varnothing$	TUBO $\varnothing$	ALTURA	REF.	PRECIO
	310 $\varnothing$	125	110	200	04100001	40,31 €
	<b>CARACTERISTICAS:</b> <ul style="list-style-type: none"> <li>• Fundición Dúctil</li> <li>• Superficie Antideslizante</li> <li>• Pintura Negra Antioxidante</li> </ul>					

TIPO CUADRADO	MODELO	TAPA $\varnothing$	TUBO $\varnothing$	ALTURA	REF.	PRECIO
	125x125	90	90	140	04100002	19,06 €
	315x315	125	96	190	04100005	41,00 €
	<b>CARACTERISTICAS:</b> <ul style="list-style-type: none"> <li>• Fundición Dúctil</li> <li>• Superficie Antideslizante</li> <li>• Pintura Negra Antioxidante</li> </ul>					

# Riego

<b>UNION GIBALT PARA PVC Y POLIETILENO (serie larga)</b>		DN	LARGO	REF.	PRECIO
	50	130	04050001	8,70 €	
	63	130	04050002	10,40 €	
	75	130	04050003	12,10 €	
	90	140	04050004	14,55 €	
	110	150	04050005	20,20 €	
	125	150	04050006	23,35 €	
	140	150	04050007	25,70 €	
	160	180	04050008	31,65 €	
	180	180	04050009	41,15 €	
	200	185	04050010	58,10 €	
	250	210	04050011	78,30 €	
	315	215	04050012	101,96 €	
	400	210		132,35 €	
	500	210		172,10 €	
<b>CARACTERISTICAS:</b> Cuerpo y Aros Laterales: Fundición GGG-40 Goma: EPDM Tornillería: Acero Zincado Pintura antioxidante					

<b>COLLARIN DE TOMA PARA PVC Y POLIETILENO</b>		DN	ROSCA MAX.	REF.	PRECIO	
	40	1"	04060001	4,88 €		
	50	1"	04060002	6,05 €		
	63	1 ¼"	04060003	7,19 €		
	75	1 ¼"	04060004	7,65 €		
	90	1"	04060005	8,32 €		
	90	1 ¼"	04060006	8,45 €		
	90	2"	04060007	16,10 €		
	110	1 ¼"	04060008	10,90 €		
	110	2"	04060009	18,20 €		
	110	2 ½"	04060010	19,24 €		
	125	1 ¼"	04060011	20,08 €		
	125	2"	04060012	21,90 €		
	125	2 ½"	04060013	23,78 €		
	125	3"	04060014	23,78 €		
	140	1 ½"	04060015	23,31 €		
	140	2"	04060016	24,13 €		
	140	3"	04060017	25,98 €		
	160	1 ¼"	04060018	20,96 €		
	160	2"	04060019	24,13 €		
	160	3"	04060020	26,04 €		
	180	1 ¼"	04060021	29,06 €		
	180	2"	04060022	29,06 €		
	180	3"	04060023	29,06 €		
	200	1 ¼"	04060024	25,45 €		
	200	2"	04060025	25,98 €		
	200	3"	04060026	30,02 €		
	250	1 ¼"	04060028	40,85 €		
	250	2"	04060029	42,12 €		
	250	2 ½"	04060030	43,18 €		
	250	3"	04060031	43,75 €		
	315	2"	04060034	49,95 €		
	315	2 ½"	04060033	62,17 €		
	315	3"	04060035	62,46 €		
	<b>CARACTERISTICAS:</b> Cuerpo: Fundición Nodular Goma: EPDM Tornillería: Acero cincado Pintura antioxidante					

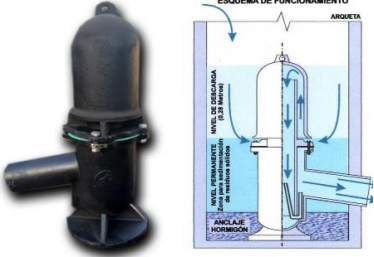
CAMARA DE DESCARGA	MODELO	REF.	PRECIO
	600 L	04290004	340,00 €
			

## Bocas De Riego

TIPO MADRID	TOMA	REF.	PRECIO
	ER45	04070003	99,00 €
	ROSCA	04070001	117,00 €

TIPO BARCELONA	TOMA	REF.	PRECIO
	ER45	04080002	99,00 €
	ROSCA	04080001	117,00 €

## Polipropileno

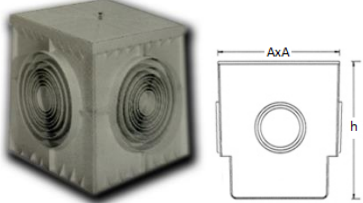
ARQUETAS	MEDIDA (AxA)	ALTURA (h)	REF.	PRECIO
	200x200	200	04170007	6,27 €
	300x300	300	04170004	10,96 €
	400x400	400	04170005	17,11 €
	550x550	520	04170006	44,70 €

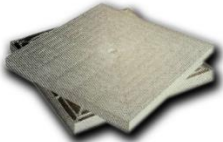
<b>TAPAS</b>		MEDIDA	REF.	PRECIO
	200x200	04170012	2,50 €	
	300x300	04170014	6,20 €	
	400x400	04170013	10,70 €	
	550x550	04170015	25,20 €	
	SIN TORNILLO			

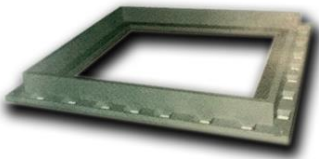
<b>MARCOS</b>		MEDIDA	REF.	PRECIO
	200x200	04170019	2,00 €	
	300x300	04170020	3,20 €	
	400x400	04170018	5,50 €	
	550x550	04170021	8,40 €	

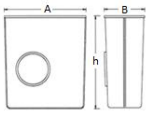
<b>CAJON SIFONICO</b>		MEDIDA (AxB)	ALTURA (h)	SALIDA Ø	REF.	PRECIO
 	420x210	400	160-200	04170002	27,80 €	
	700x300	650	160-200	04170003		

<b>SUMIDEROS</b>		MEDIDA	SALIDA TUBO Ø	REF.	PRECIO
	150x150	50	04170008	3,36 €	
	200x200	75	04170009	6,51 €	
	250x250	75	04170010	9,42 €	
	300x300	90	04170011	11,94 €	

<b>CANAL Y REJA</b>		MEDIDA	ALTURA	REF.	PRECIO
	1000x130	40		46,50 €	
	1000x130	95	04170017	49,60 €	
	1000x130	170		63,90 €	
	1000x200	95		111,90 €	
	1000x200	170		126,30 €	

<b>PATE</b>	MEDIDA (AxB)	REF.	PRECIO
	360x235	04170001	4,00 €

## Sumideros y Tapas Inoxidables (AISI 304)

<b>SUMIDEROS</b>	MEDIDA	SALIDA Ø	REF.	PRECIO
	100x100	33	04240001	16,60 €
	125x125	40	04240002	22,10 €
	150x150	50	04240003	28,00 €
	200x200	75	04240004	47,80 €
	250x250	90	04240005	114,30 €
	300x300	90	04240006	159,80 €

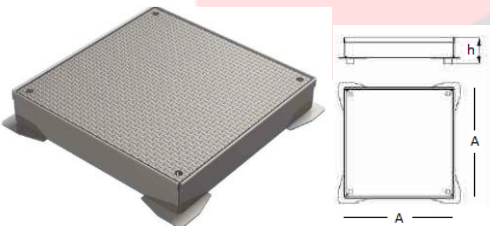
<b>TAPAS</b>	MEDIDA A x A (tapa)	ALTURA (h)	REF.	PRECIO
	300x300	69	04220002	106,50 €
	400x400	69	04220003	149,10 €
	500x500	69	04220004	233,10 €
	600x600	69	04220005	254,20 €
	700x700	69	04220006	344,40 €
	800x800	69	04220007	451,50 €
	900x900	69	04220012	571,20 €
	1000x1000	69	04220013	705,60 €

<b>PUERTAS DE CONTADOR</b>	MEDIDA (tapa)	MARCO	REF.	PRECIO
	350x250	400x300		50,40 €
	450x300	500x350		63,00 €





# Sumideros Y Tapas Cincado

SUMIDEROS	MEDIDA	SALIDA $\varnothing$	REF.	PRECIO
	100x100	33	04230001	8,20 €
	125x125	40	04230006	11,40 €
	150x150	50	04230002	15,10 €
	200x200	75	04230003	20,30 €
	250x250	90	04230004	35,10 €
	300x300	90	04230005	49,20 €

TAPAS	MEDIDA A x A (tapa)	ALTURA (h)	REF.	PRECIO
	300x300	69	04220008	39,20 €
	400x400	69	04220009	54,90 €
	500x500	69	04220011	87,00 €
	600x600	69	04220010	102,25 €
	700x700	69	04220014	136,50 €
	800x800	69	04220015	161,70 €
	900x900	69	04220016	184,80 €
	1000x1000	69	04220017	201,60 €

# Señalización Eléctrica

TAPA	MEDIDA	REF.	PRECIO
	230x165	04260001	11,50 €

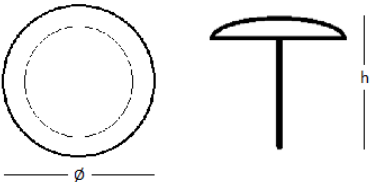
CHINCHETA	MEDIDA	ALTURA (h)	REF.	PRECIO
	140 $\varnothing$	190	04320001	21,30 €
				

# Manguito Reducción

Manguito Reducción	MEDIDA	ROSCA	SALIDA Ø	REF.	PRECIO
	105	1,5"	90	04330001	9,50 €

# Contrapesos

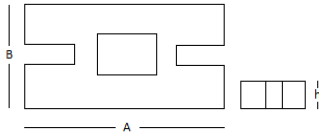
ELEVACION	PESO	MEDIDA (A x B)	ALTURA (h)	REF.	PRECIO
 	12,5 kg.	340x155	47	34010029	25,00 €

BASCULAS	PESO	REF.	PRECIO
	20 kg.	48010001	66,00 €

# Pesas De Balanza

Pesas De Balanza	PESO	REF.	PRECIO
	100 gr.	04160001	4,21 €
	200 gr.	04160002	4,56 €
	250 gr.	04160003	4,90 €
	500 gr.	04160004	5,95 €
	1 kg.	04160005	7,28 €
	2 kg.	04160006	12,06 €
	5 kg.	04160007	26,22 €
	10 kg.	04160008	48,97 €
	20 kg.	04160009	90,95 €

# Cubrebajantes

Cubrebajantes	MEDIDA	INTERIOR Ø	REF.	PRECIO
	1650	110	04350001	102,60 €
	1000	90	04350002	65,80 €

# Poleas

Poleas	MEDIDA Ø	REF.	PRECIO
	120	04150001	12,10 €
	160	04150002	14,30 €
	200	04150003	16,50 €

# Pisones

Pisones	MEDIDA	REF.	PRECIO
	150x150	04140001	8,85 €
	180x180	04140002	13,53 €
	200x200	04140003	17,71 €
	250x250	04140004	25,57 €

# Calderos Y Planchas

<b>Caldero Del Mar Menor</b>	RACIONES	REF.	PRECIO
	10	04130001	85,74
	12	04130002	95,31
	14	04130003	104,83

<b>PLANCHAS DE ASAR</b>

PREGUNTAR MEDIDAS Y PRECIOS EN FABRICA

# -MOBILIARIO URBANO- Pilonas

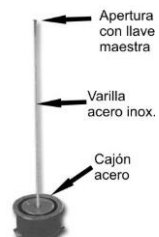
PILONAS MOD. 1		MODELO	ALTURA	REF.	PRECIO
	1	1000	05010001	38,00€	
	1 (EXTRAIBLE)	1000	05010002	110,00 €	
	 <p>ESQUEMA DEL ACCESORIO EXTRAIBLE</p>				

PILONAS MOD. 2		MODELO	ALTURA	REF.	PRECIO
	2	700	05010003	58,50 €	
	2 (EXTRAIBLE)	700	05010004	130,00 €	

PILONAS MOD. 3		MODELO	ALTURA	REF.	PRECIO
	3G	700	05010005	58,50 €	
	3G (EXTRAIBLE)	700	05010006	130,00 €	
	3P	500	05010007	47,25 €	
	3P (EXTRAIBLE)	500	05010008	120,00 €	

PILONAS MOD. 4		MODELO	ALTURA	REF.	PRECIO
	4	700	05010009	38,50 €	

<b>PILONAS MOD. 5</b>		MODELO	ALTURA	REF.	PRECIO
	5P	300 Ø	05010010	86,00 €	
	5G	400 Ø		162,80 €	

<b>PILONAS MOD. 6</b>		MODELO	ALTURA	REF.	PRECIO
	6G	620	05010011	178,00 €	
	6G (EXTRAIBLE)	620	05010012	258,00 €	
	6P	500	05010013	73,80 €	
	6P (EXTRAIBLE)	500	05010014	154,00 €	

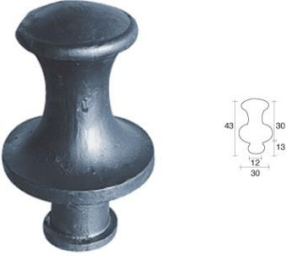
<b>PILONAS MOD. 7</b>		MODELO	ALTURA	REF.	PRECIO
	7	450		74,00 €	

<b>PILONAS MOD. 8</b>		MODELO	ALTURA	REF.	PRECIO
	8	1000		82,30 €	

<b>PILONAS MOD. 9</b>		MODELO	ALTURA	REF.	PRECIO
	9	450		157,60 €	

PILONAS MOD. 10	MODELO	ALTURA	REF.	PRECIO
	10	900		56,80 €

## Bancos

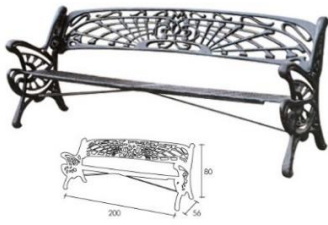
Banco MOD. 1	MODELO	REF.	PRECIO
	1	05020001	340,00 €
	<b>CARACTERISTICAS:</b> PIES: fundición dúctil ASIENTO Y RESPALDO: fundición dúctil		

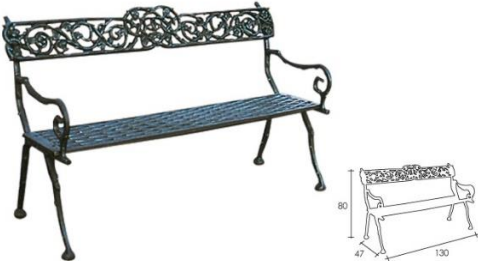
Banco MOD. 2	MODELO	REF.	PRECIO
	2	05020002	290,00 €
	<b>CARACTERISTICAS:</b> PIES: fundición dúctil ASIENTO Y RESPALDO: fundición dúctil		

Banco MOD. 3	MODELO	REF.	PRECIO
	3	05020003	310,00 €
	<b>CARACTERISTICAS:</b> PIES: pletina de acero ASIENTO Y RESPALDO: madera con tratamiento fungicida, insecticida e hidrófugo		



Banco MOD. 4	MODELO	REF.	PRECIO
	4	05020004	283,50 €
	<b>CARACTERISTICAS:</b> PIES: fundición dúctil ASIENTO Y RESPALDO: madera con tratamiento fungicida, insecticida e hidrófugo		

Banco MOD. 5	MODELO	REF.	PRECIO
	5	05020005	283,50 €
	<b>CARACTERISTICAS:</b> PIES: fundición dúctil ASIENTO Y RESPALDO: madera con tratamiento fungicida, insecticida e hidrófugo		

Banco MOD. 6	MODELO	REF.	PRECIO
	6	05020006	440,00 €
	<b>CARACTERISTICAS:</b> PIES: fundición dúctil ASIENTO Y RESPALDO: madera con tratamiento fungicida, insecticida e hidrófugo		

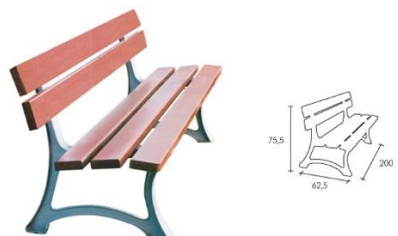
Banco MOD. 7	MODELO	REF.	PRECIO
	7	05020008	250,00 €
	<b>CARACTERISTICAS:</b> PIES: fundición dúctil ASIENTO Y RESPALDO: madera con tratamiento fungicida, insecticida e hidrófugo		

Banco MOD. 8	MODELO	REF.	PRECIO
	8	05020009	331,80 €
	<b>CARACTERISTICAS:</b> PIES: fundición dúctil ASIENTO Y RESPALDO: madera con tratamiento fungicida, insecticida e hidrófugo		

# Papeleras

Papeleras MOD. 1			
MODELO	REF.	PRECIO	
1	05030001	208,00 €	
		<p><b>CARACTERÍSTICAS:</b>                      Papelera con estructura interior metálica de acero galvanizado y recubierto en su parte exterior con listones de madera tropical tratada con protector fungicida, insecticida e hidrófugo. Acabado en color caoba.</p>	

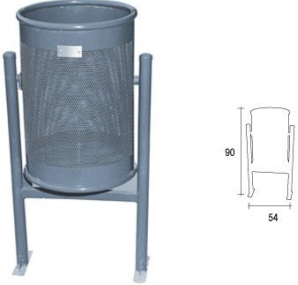
Papeleras MOD. 2			
MODELO	REF.	PRECIO	
2	05030002	75,60 €	
2 SEMI	05030008	85,00 €	
2 FUNDI			
		<p><b>CARACTERÍSTICAS:</b>                      Papelera de cincado electrolítico por inmersión, con una posterior capa de imprimación y otra de esmalte en color gris.                      Formada por una cubeta circular abatible en plancha de acero perforado, insertada en una estructura de tubo con base de anclaje y pletinas rectangulares con dos agujeros para su fijación en el suelo.</p>	

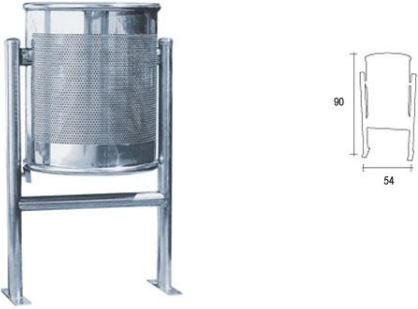
Papeleras MOD. 3			
MODELO	REF.	PRECIO	
3 INOX	05030003	300,00 €	
3 INOX SEMI	05030006	320,00 €	
		<p><b>CARACTERÍSTICAS:</b>                      Papelera formada por una cubeta circular abatible en plancha de acero inoxidable perforado, insertada en una estructura de tubo de acero, con base de anclaje y pletinas rectangulares con dos agujeros, para su fijación al suelo.</p>	

Papeleras MOD. 4		MODELO	REF.	PRECIO
	4	05030004	89,90 €	
	4 DOBLE		155,00 €	
	4 PARED		105,00 €	
	<b>CARACTERÍSTICAS:</b> Papelera de cincado electrolytico por inmersión, acabada en color negro forja. Formada por un poste de fijación y dos cubetas cilíndricas en plancha embutida. Instalación mediante empotramiento en el suelo.			

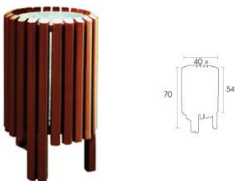
Papeleras MOD. 5		MODELO	REF.	PRECIO
	5	05030005	208,00 €	
	<b>CARACTERÍSTICAS:</b> Papelera con estructura interior metálica de acero galvanizado y exterior con 24 listones de madera tropical tratada con protector fungicida, insecticida e hidrófugo. Acabado en color caoba.			

## Alcorques

Alcorques MOD. 1		MODELO	MEDIDA	INT. Ø	REF.	PRECIO
	1	1000x1000	400	05040002	141,80 €	
	1	1200x1200	500	05040003	207,90 €	
	<b>CARACTERÍSTICAS:</b> Alcorque realizado en fundición dúctil y acabado en color negro Consta de dos piezas					

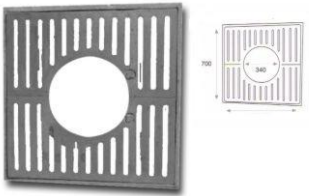
Alcorques MOD. 2		MODELO	MEDIDA	INT. Ø	REF.	PRECIO
	2	700x700	340	05040004	89,70 €	
	<b>CARACTERÍSTICAS:</b> Alcorque realizado en fundición dúctil y acabado en color negro Consta de dos piezas					

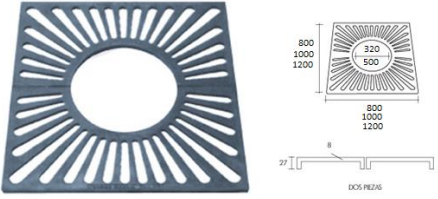
<b>Alcorques MOD. 3</b>	MODELO	MEDIDA	INT. Ø	REF.	PRECIO
	3	800x800	320	05040011	99,30 €
	3	1000x1000	500	05040005	118,20 €
	3	1200x1200	500	05040012	242,00 €
<b>CARACTERÍSTICAS:</b> Alcorque realizado en fundición dúctil y acabado en color negro Consta de dos piezas					

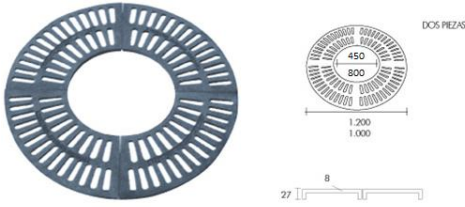

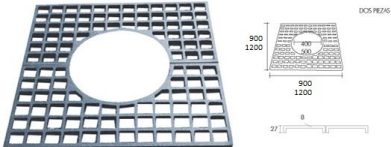
<b>Alcorques MOD. 4</b>	MODELO	MEDIDA Ø	INT. Ø	REF.	PRECIO
	4	600	200	05040006	59,00 €
	4	1200	450	05040007	189,00 €
	4	1200	800	05040008	210,00 €
<b>CARACTERÍSTICAS:</b> Alcorque realizado en fundición dúctil y acabado en color negro Consta de dos piezas					

<b>Alcorques MOD. 5</b>	MODELO	MEDIDA	INT. Ø	REF.	PRECIO
	5	900x900	400		118,20 €
	5	1200x1200	500		237,30 €
<b>CARACTERÍSTICAS:</b> Alcorque realizado en fundición dúctil y acabado en color negro Consta de dos piezas					

## Jardineras

<b>Jardinera MOD. 1</b>	MODELO	MEDIDA	REF.	PRECIO
	1	800x300x320	05050001	312,00 €

Jardinera MOD. 2	MODELO	MEDIDA Ø	REF.	PRECIO
	2 PEQ.	900	05050002	302,00 €
	2 GR.	1350	05050003	688,00 €

Jardinera MOD. 3	MODELO	MEDIDA	REF.	PRECIO
	3 (cuadrada peq.)	450x450x340		
	3 (cuadrada gr.)	700x700x440		370,00 €
Jardinera MOD. 4				
	4 (rectangular peq.)	800x300x300		142,00 €
	4 (rectangular gr.)	1200x500x420		412,00 €
Jardinera MOD. 5				
	5 (hexagonal peq.)	480		
	5 (hexagonal gr.)	800		550,00 €

## Fuentes

Fuente MOD. 1	MODELO	REF.	PRECIO
	1	05060001	650,00 €
	1 DOBLE		
	<p><b>CARACTERÍSTICAS:</b> Fuente realizada en fundición dúctil y revestida con una capa de imprimación y dos en color negro forja Grifo pulsador de latón</p>		

Fuente MOD. 2	MODELO	REF.	PRECIO
	2	05060002	
	2 DOBLE		
	<b>CARACTERÍSTICAS:</b> Fuente realizada en fundición dúctil y revestida con una capa de imprimación y dos en color negro forja Grifo pulsador de latón		

Fuente MOD. 3	MODELO	REF.	PRECIO
	3	05060003	276,00 €
	<b>CARACTERÍSTICAS:</b> Fuente realizada en fundición dúctil y revestida con una capa de imprimación y dos en color negro forja Grifo pulsador de latón		

Fuente MOD. 4	MODELO	REF.	PRECIO
	4 (INFANTIL)	05060004	244,00 €
	<b>CARACTERÍSTICAS:</b> Fuente realizada en fundición dúctil y revestida con una capa de imprimación y dos en color negro forja Grifo pulsador de latón		

Fuente MOD. 5	MODELO	REF.	PRECIO
	5	05060006	
	<b>CARACTERÍSTICAS:</b> Fuente realizada en fundición dúctil y revestida con una capa de imprimación y dos en color negro forja Grifo pulsador de latón		

Fuente MOD. 6	MODELO	REF.	PRECIO
	6	05060005	390,00 €
	<b>CARACTERÍSTICAS:</b> Cuerpo cuadrado de hierro Pletina fijación y grifo pulsador de acero niquelado Reja sumidero de fundición dúctil y marco de hierro Fuente revestida con una capa de imprimación y dos en color negro forja		

Fuente MOD. 7	MODELO	REF.	PRECIO
	7		390,00 €
	<b>CARACTERÍSTICAS:</b> Cuerpo circular de hierro Pletina fijación y grifo pulsador de acero niquelado Reja sumidero de fundición dúctil y marco de hierro Fuente revestida con una capa de imprimación y dos en color negro forja		

Fuente MOD. 8	MODELO	REF.	PRECIO
	8 (CANINA)		1030,00 €
	<b>CARACTERÍSTICAS:</b> Cuerpo cuadrado de acero inoxidable Pletina fijación y grifo pulsador de acero niquelado		

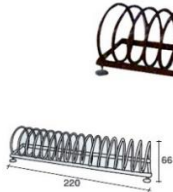

# Aparcabicis

Aparcabicis MOD. 1	MODELO	REF.	PRECIO
	1		158,00 €
	<b>CARACTERISTICAS:</b> -Fabricado en acero galvanizado -Capacidad: 10 Bicicletas		

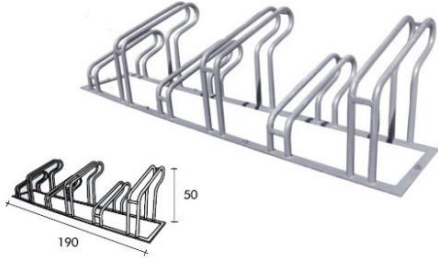
Aparcabicis MOD. 2	MODELO	REF.	PRECIO
	2		180,00 €
	<b>CARACTERISTICAS:</b> -Fabricado en acero galvanizado -Capacidad: 6 Bicicletas		

Aparcabicis MOD. 3	MODELO	REF.	PRECIO
	3 GALVANIZADO		73,70 € €
	3 INOX.		
	<b>CARACTERISTICAS:</b> -Fabricado en acero galvanizado o inoxidable		

## Contrapesos Tractor



DISPONEMOS DE GRAN CANTIDAD DE REFERENCIAS PARA TODAS LAS MARCAS.  
ESTO SON SOLAMENTE UNAS MUESTRAS.

## Poleas De Siembra



DIAMETRO Ø	REF.	PRECIO
250	55090001	22,50 €

# SECTOR NAVAL

## Bolardos (Norays)

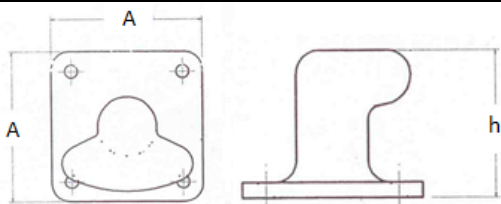

	BASE (AxA)	ALTURA (h)	TIRO	PESO	REF.	PRECIO
	180x180	150	6 Tn.	12 Kg.	04210001	30,03 €
	200x200	190	8 Tn.	16,5 Kg.	04210002	41,17 €
	230x230	210	10 Tn.	27 Kg.	04210008	66,15 €
	250x250	250	12 Tn.	36 Kg.	04210003	81,00 €
	350x350	300	15 Tn.	70 Kg.	04210004	160,08 €
	460x460	350	30 Tn.	150 Kg.	04210005	343,03 €
	550x550	520	50 Tn.	360 Kg.	04210006	950,00 €
1000x1000	750	80 Tn.	920 Kg.	04210007	2103,00 €	
						

## Quillas (Orzas)



Contrapesos Redes	ALTURA	INTERIOR Ø	REF.	PRECIO
	70	45	39010001	8,50 €

# SECTOR INDUSTRIAL

CUERPO BOMBA	CUERPO BOMBA (TAPA)	CUERPO ASPIRACION
		
PIÑON	PLATO MOLINO	
